

1H (1000TP101) pag 3-6

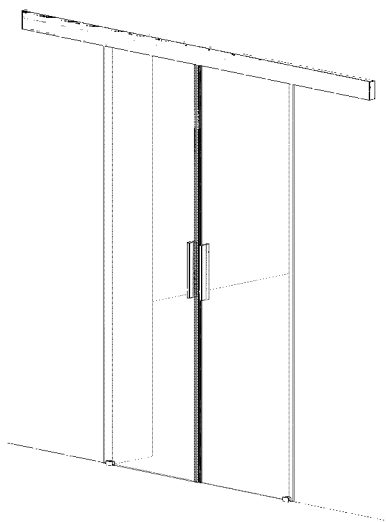

2H (1000TP103) pag 11-14

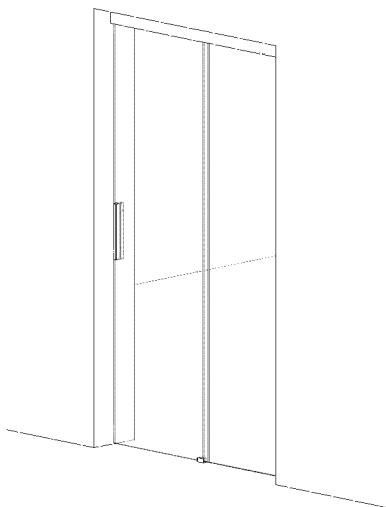

1F+1H (2000TP102) pag 7-10

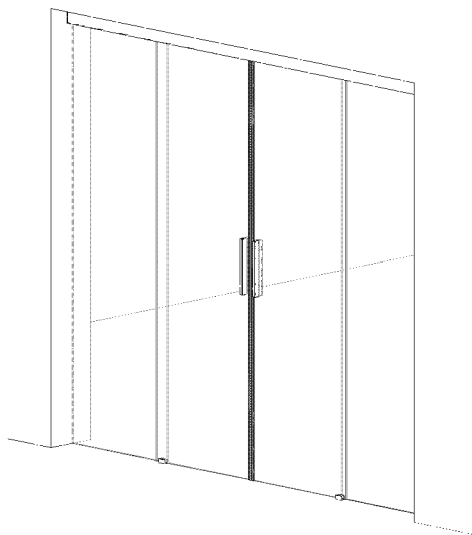



2F+2H (2000TP104) pag 15-18













Descripción componentes

Puertas De Paso

PERFILES

		REFERENCIA	DESCRIPCION
①		30030001	Perfil guía superior puerta de paso
②		30030005	Perfil guía fijo puerta de paso
③		30030010	Perfil tapeta puerta de paso

COMPLEMENTOS

		REFERENCIA	DESCRIPCION
(A)		30021001	Perfil goma burbuja para cristal 8-10 mm.
(B)		30030011	Clips de anclaje para perfil tapeta
(C)*		30030015-IZQ	Embellecedor guía puerta de paso Izq.
(D)*		30030015-DRCHA	Embellecedor guía puerta de paso Drcha.
(E)*		30030020-IZQ	Embellecedor guía fijo puerta de paso Izq.
(F)*		30030020-DRCHA	Embellecedor guía fijo puerta de paso Drcha.
(G)		30030040-1	Set accesorios puerta de paso 90 Kg. (Pinza)
(H)		30030040-2	Set accesorios puerta de paso 90 Kg. (Rodamiento)
(I)		30030040-3	Set accesorios puerta de paso 90 Kg. (Tope de freno)
(J)		30030040-4	Set accesorios puerta de paso 90 Kg. (Guiador)
(K)		12105210	Goma burbuja con adhesivo
(L)		12307380	Tirador pletina Nº8 de 27x14x300 mm.

* Guarda mano

Esquema de Componentes

Mod. 1H (1000TP101)











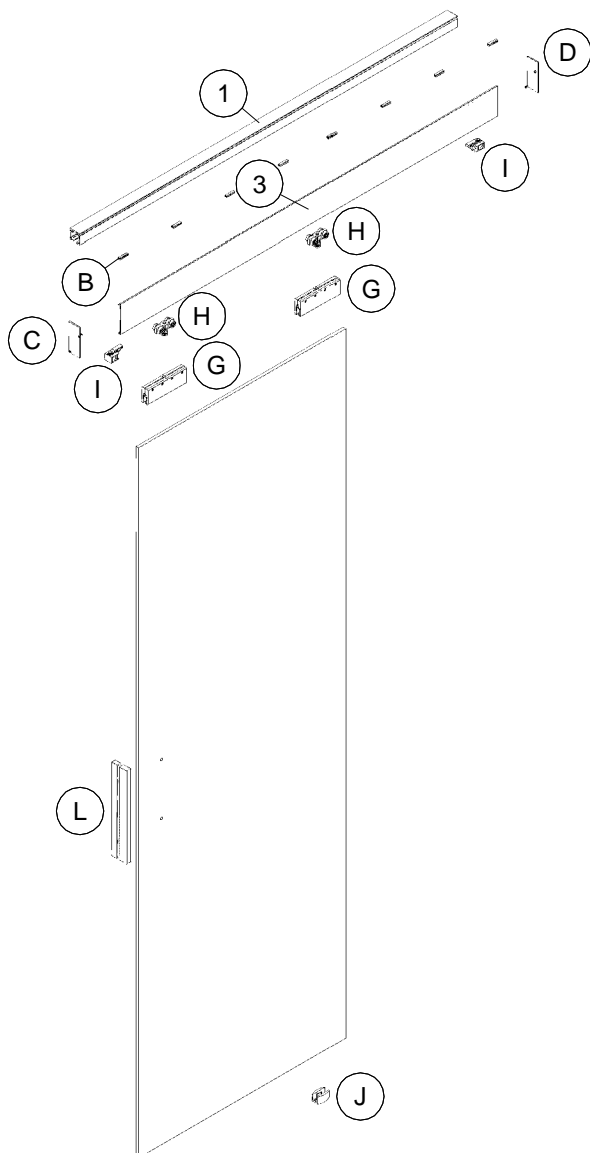

Tabla de componentes

Mod. 1H (1000TP101)

MODELO 1H (1000TP101)

PERFILES		
	Referencia	Unidades
① 	30030001	1
③ 	30030010	1

COMPLEMENTOS		
	Referencia	Unidades
Ⓑ 	30030011	10
Ⓒ* 	30030015-IZQ	1
Ⓓ* 	30030015-DRCHA	1
Ⓖ 	30030040-1	2
Ⓗ 	30030040-2	2
Ⓘ 	30030040-3	2
Ⓙ 	30030040-4	1
Ⓛ 	12307380	1

* Guarda mano

Instrucciones de Montaje

Mod. 1H (1000TP101)

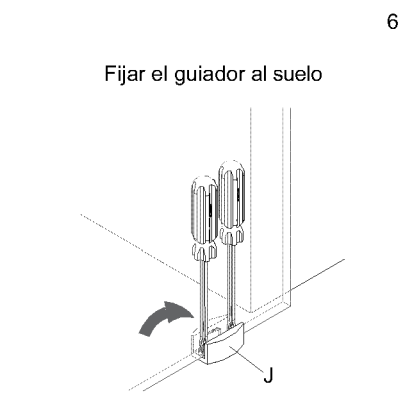
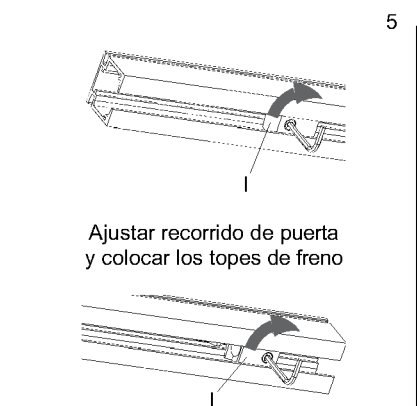
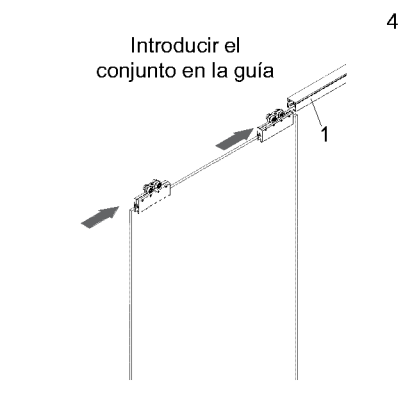
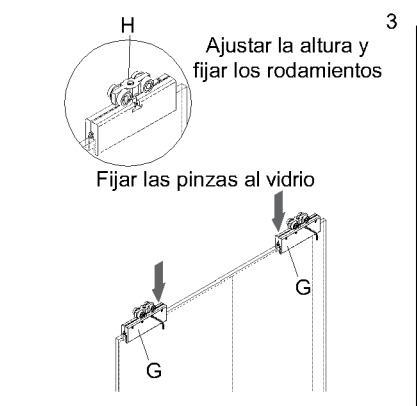
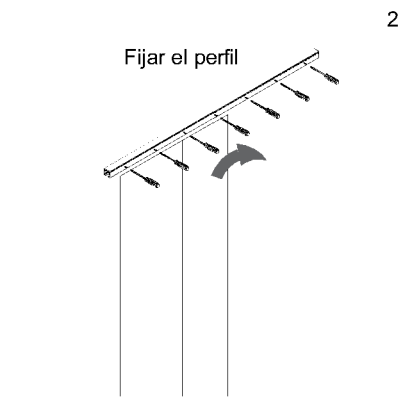
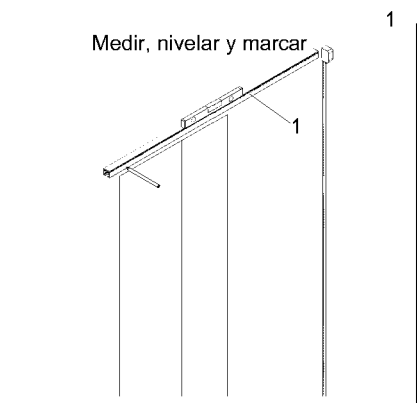

Instrucciones de Montaje

Mod. 1H (1000TP101)

7

Colocar los clips en la tapeta para fijar ésta al perfil

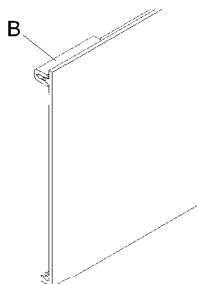

8

Fijar la tapeta al perfil

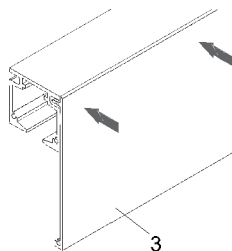

9

Colocar los embellecedores laterales

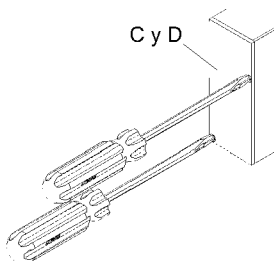

10

Colocar y fijar el tirador

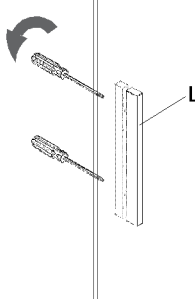

Esquema de Componentes Mod. 1F+1H (2000TP102)











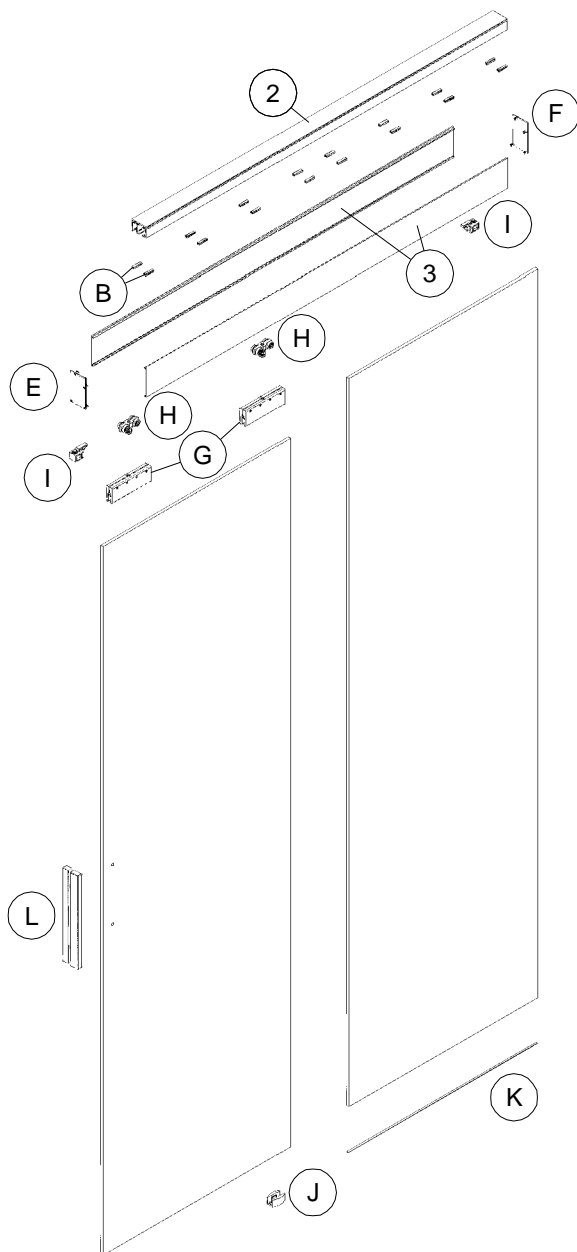



Tabla de componentes

Mod. 1F+1H (2000TP102)

MODELO 1F+1H (2000TP102)

PERFILES		
	Referencia	Unidades
① 	30030005	1
③ 	30030010	2

COMPLEMENTOS		
	Referencia	Unidades
Ⓑ 	30030011	20
Ⓒ* 	30030015-IZQ	1
Ⓓ* 	30030015-DRCHA	1
Ⓖ 	30030040-1	2
Ⓕ 	30030040-2	2
Ⓖ 	30030040-3	2
Ⓖ 	30030040-4	1
Ⓖ 	12105210	1
Ⓖ 	12307380	1

* Guarda mano

Instrucciones de Montaje

Mod. 1F+1H (2000TP102)

EKO

1

Medir y marcar 2

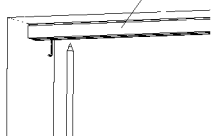

*Colocar los embellecedores laterales E y F "solo para perfil en pared".

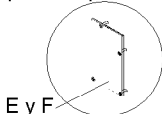

2

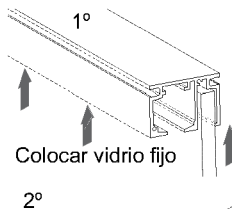

Colocar vidrio fijo

2°

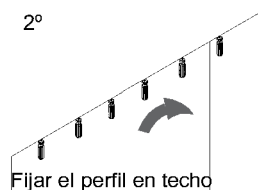

Fijar el perfil en techo

3

Ajustar la altura y
fijar los rodamientos

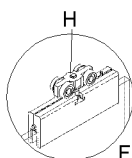

Fijar las pinzas al vidrio

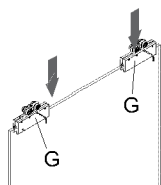

4

Introducir el
conjunto en la guía

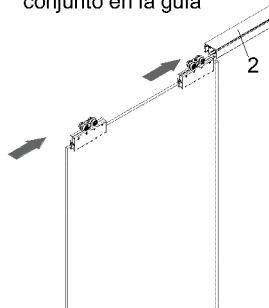

5

Ajustar recorrido de puerta
y colocar los topes de freno

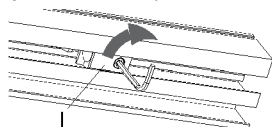

6

Fijar el guiador al suelo

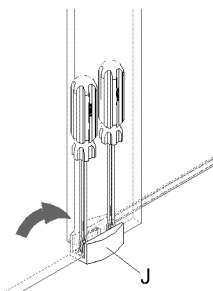

Instrucciones de Montaje

Mod. 1F+1H (2000TP102)

7

Colocar los clips en la tapeta para fijar ésta al perfil

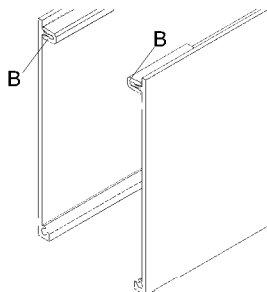

8

Fijar la tapeta al perfil

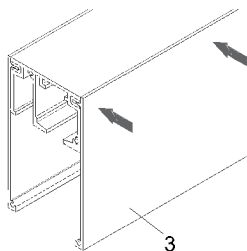

9

Colocar y fijar el tirador

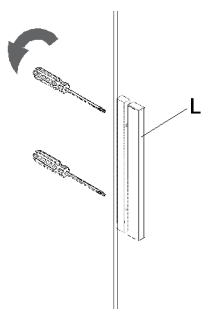

Esquema de Componentes

Mod. 2H (1000TP103)











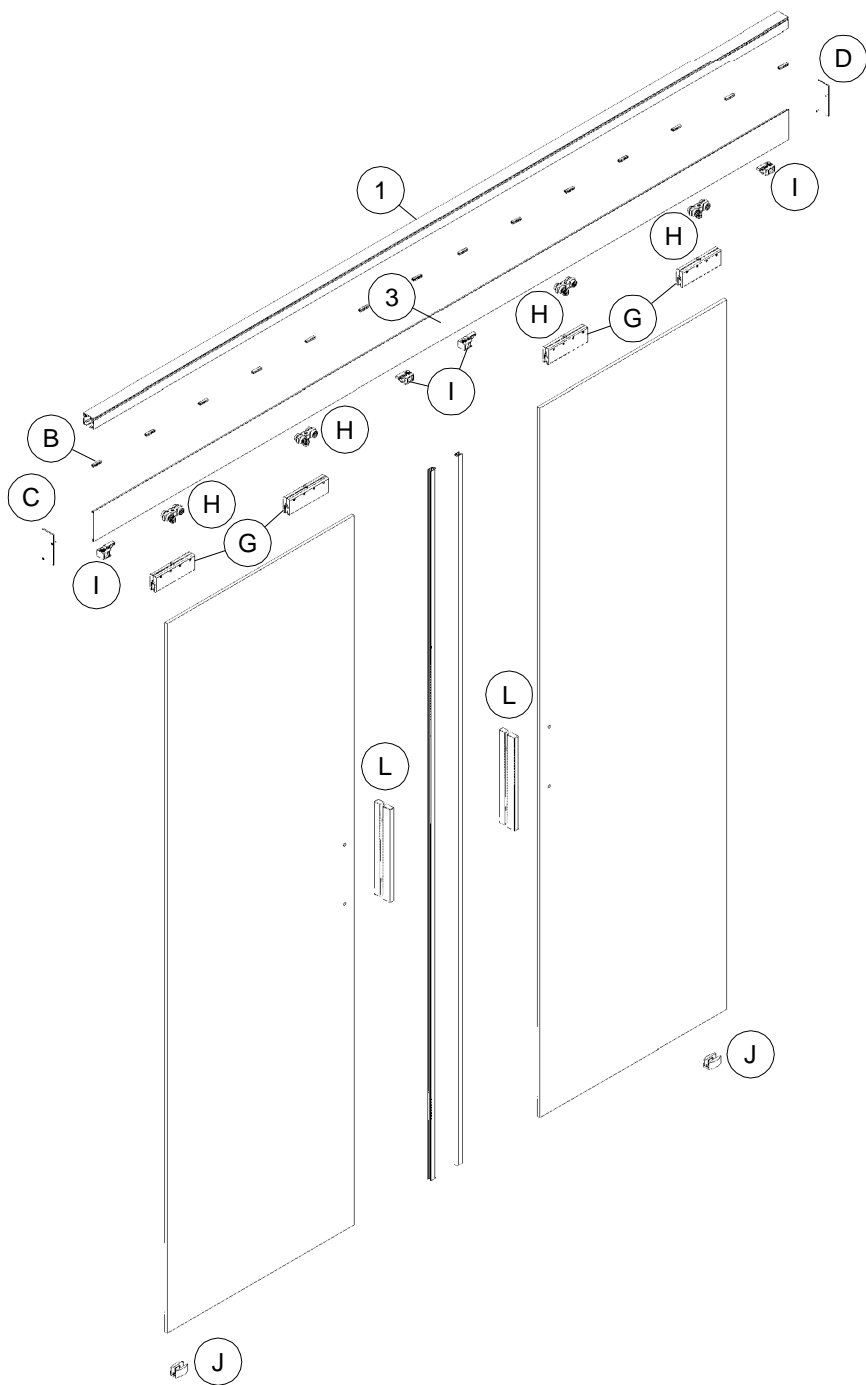

Tabla de componentes

Mod. 2H (1000TP103)

MODELO 2H (1000TP103)

PERFILES		
	Referencia	Unidades
① 	30030001	1
③ 	30030010	1

COMPLEMENTOS		
	Referencia	Unidades
Ⓑ 	30030011	15
Ⓒ* 	30030015-IZQ	1
Ⓓ* 	30030015-DRCHA	1
Ⓖ 	30030040-1	4
Ⓕ 	30030040-2	4
Ⓖ 	30030040-3	2
Ⓖ 	30030040-4	2
Ⓖ 	12307380	2

* Guarda mano

Instrucciones de Montaje

Mod. 2H (1000TP103)

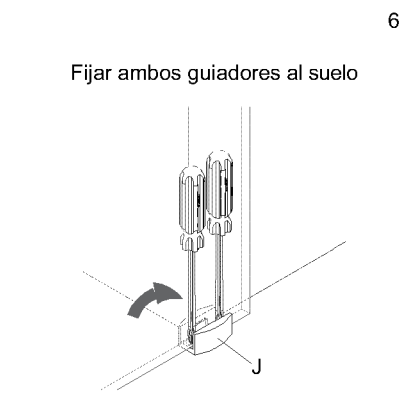
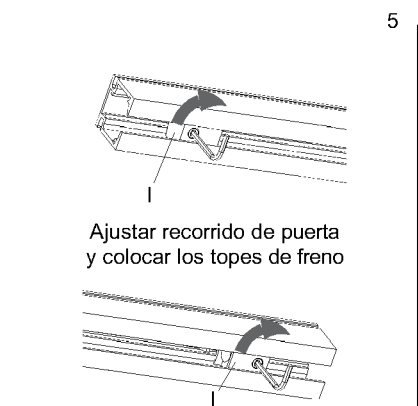
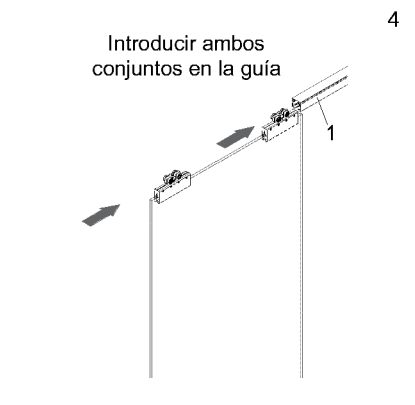
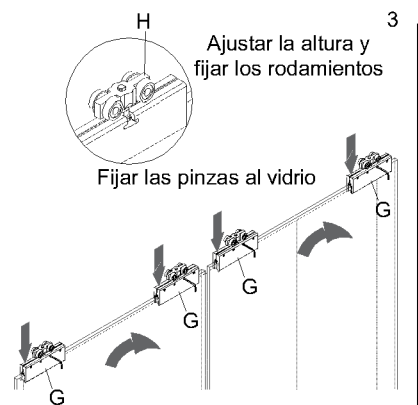
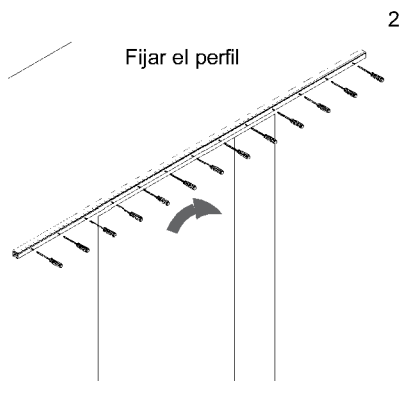
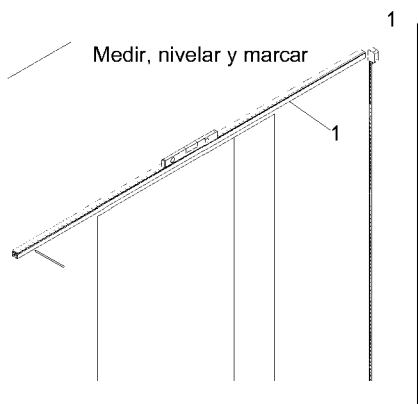

Instrucciones de Montaje

Mod. 2H (1000TP103)

7

Colocar los clips en la tapeta para fijar ésta al perfil

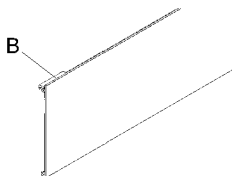

8

Fijar la tapeta al perfil

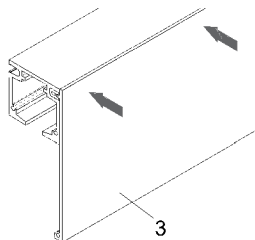

9

Colocar los embellecedores laterales

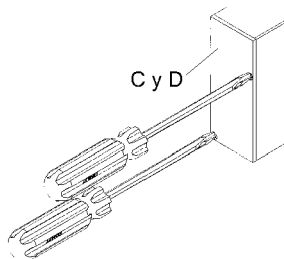

10

Colocar los perfiles goma burbuja

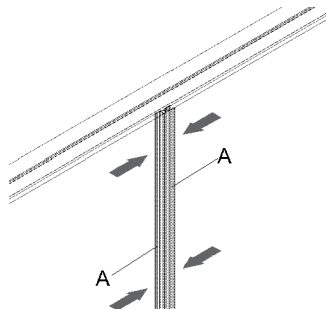

11

Colocar y fijar los tiradores

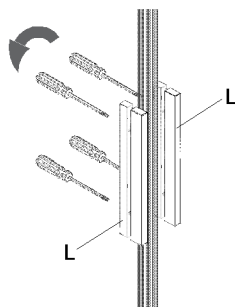

Esquema de Componentes Mod. 2F+2H (2000TP104)











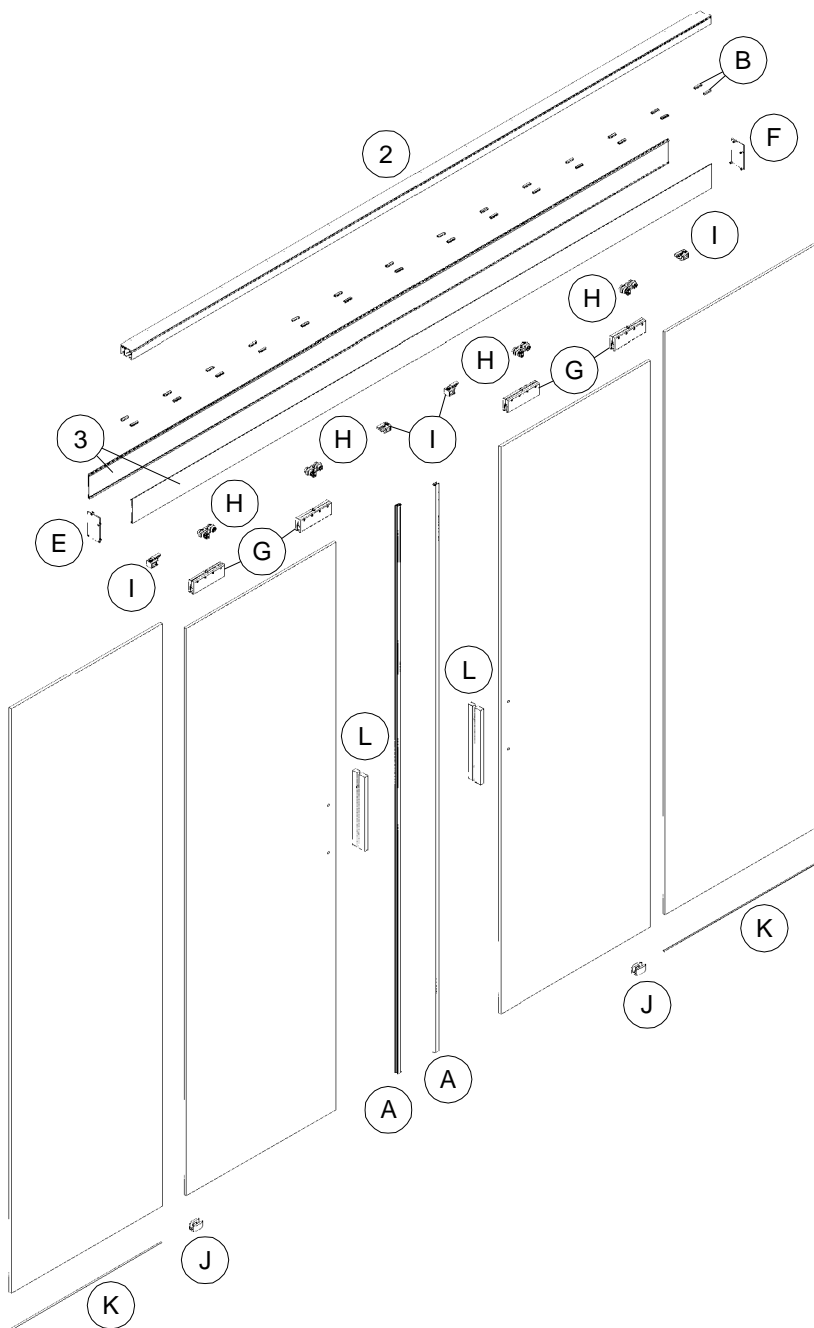



Tabla de componentes

Mod. 2F+2H (2000TP104)



MODELO 2F+2H (2000TP104)

PERFILES		
	Referencia	Unidades
① 	30030005	1
③ 	30030010	2

COMPLEMENTOS		
	Referencia	Unidades
Ⓑ 	30030011	30
Ⓒ* 	30030015-IZQ	1
Ⓓ* 	30030015-DRCHA	1
Ⓖ 	30030040-1	4
Ⓕ 	30030040-2	4
Ⓖ 	30030040-3	2
Ⓖ 	30030040-4	2
Ⓖ 	12105210	2
Ⓖ 	12307380	2

* Guarda mano

Instrucciones de Montaje

Mod. 2F+2H (2000TP104)

EKO

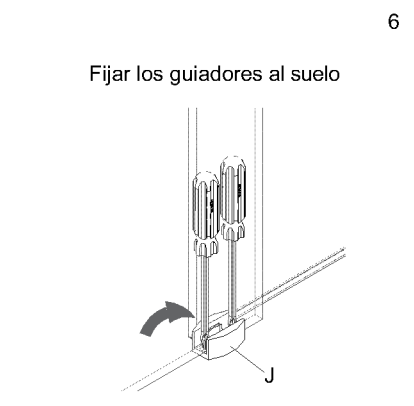
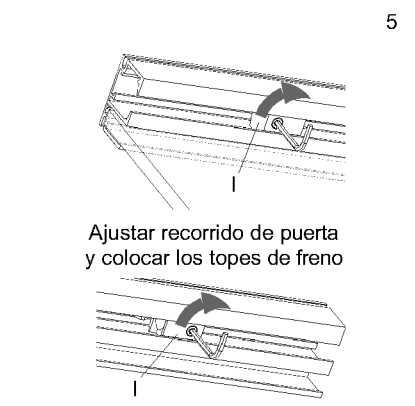
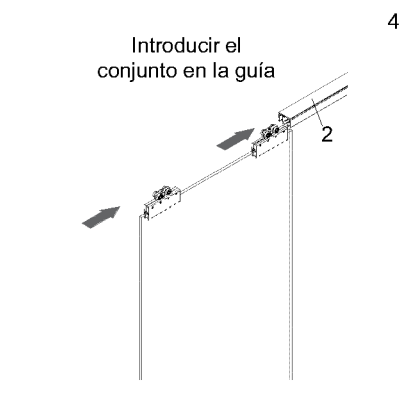
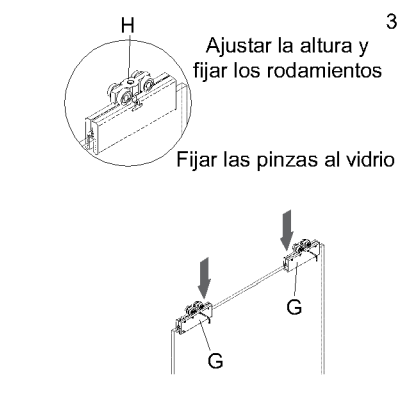
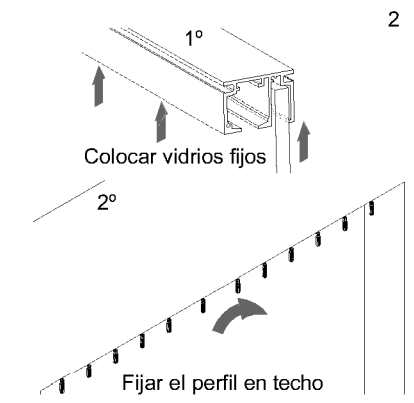
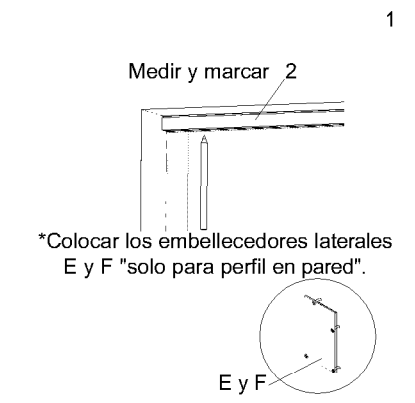

Instrucciones de Montaje

Mod. 2F+2H (2000TP104)

7

Colocar los clips en la tapeta para fijar ésta al perfil

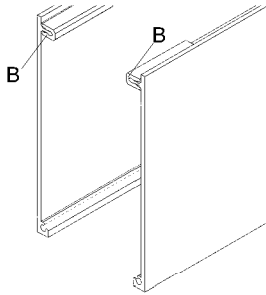

8

Fijar la tapeta al perfil

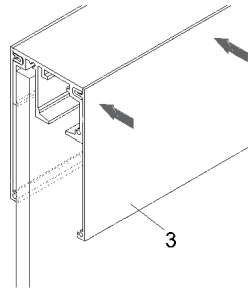

9

Colocar y fijar los tiradores

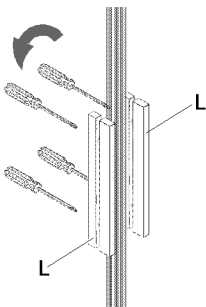

KIT ACCESORIOS PUERTAS DE PASO

Kits Accesorios Puertas de Paso



Referencia	Denominación
14006510	Bolsa de accesorios Puertas de Paso

KIT ACCESORIOS 1H-1F+1H-2H-2F+2H

Referencia	Denominación	Unidades
12200720	Tornillo R.Chapa DIN 7982 4,2x38 CAB.8	6
12203110	Tornillo T.R. Aglomerada C/Avellanada PZ A2 5x40	5 Uds./mt
14200110	Llave Allen Zincada 4 mm. DIN 911	1
14200140	Llave Allen Zincada 3 mm. DIN 911	1
14200340	Bolsa Mini Grip N°1 (60x80 mm)	1
14200350	Bolsa Mini Grip N°6 (160x220 mm)	1
14200420	Instrucciones de Montaje bolsas de garantía	1
14200840	Llave Allen Zincada 2,5 mm. DIN 911	1
14202930	Tacos plástico pared SX 6x30	5 Uds./mt



EKO
BATH EXPERTISE

ECOMAMPARA, S.A.

POL. INDUSTRIAL MONTE BOYAL
AVDA. DE LA CONSTITUCIÓN, 295
45950 CASARRUBIOS DEL MONTE
TOLEDO - ESPAÑA

www.ecomampara.com